

Thermal shock measurements and modelling for solid high-power targets at high temperatures

J.R.J. Bennett^{a,*}, G.P. Skoro^b, C. Booth^b, S.J. Brooks^a, R.A. Brownsword^a,
T.R. Edgecock^a, C.J. Densham^a, S.A. Gray^a, A.J. McFarland^a, N. Simos^c, D. Wilkins^a

^a CCLRC, Rutherford Appleton Laboratory, Chilton, Didcot, Oxon OX11 0QX, UK

^b Department of Physics and Astronomy, University of Sheffield, Sheffield S3 7RH, UK

^c Brookhaven National Laboratory, P.O. Box 5000, Upton, NY 11973-5000, USA

Abstract

A description of lifetime shock tests on tantalum and tungsten is given and of modelling studies as part of the research into solid targets for a Neutrino Factory. A fast high current pulse is applied to a thin wire of the sample material and the number of pulses measured before the wire visibly deteriorates. These measurements are made at temperatures up to ~ 2000 K. The stress on the wire is calculated and compared to the stress expected in the target using the computer code LS-DYNA. It has been found that tantalum is too weak to sustain prolonged stress at these temperatures but a tungsten wire has reached over 13 million pulses (equivalent to 10 years of operation) at the stress expected in the target. Further work is in progress to study graphite and other materials. Measurement of the surface acceleration of the wire using a VISAR are to be made, which, combined with LS-DYNA modelling, will allow the evaluation of the constitutive equations of state of the materials at high temperature and provide a more accurate model of the stresses in a number of target geometries.

© 2008 Elsevier B.V. All rights reserved.

1. Introduction

There are proposals [1] to build a Neutrino Factory in the US, Europe and Japan, in order to understand some of the basic properties of neutrinos. The Neutrino Factory will consist of a proton driver accelerator delivering short pulses of beam to a heavy metal target at GeV energies at up to ~ 50 Hz, with a mean power of ~ 4 MW. As a result of the beam interaction with the target, copious amounts of pions will be produced, as well as other secondary products. The pions decay to muons which are focussed and accelerated to tens of GeV. The muons then circulate in a large storage/decay ring with long straight sections where they decay to neutrinos. The neutrinos come off in a narrow cone along the axis of the muon beam and the arms of the decay ring are directed at suitable neutrino

detectors many km distant. Fig. 1 shows the Neutrino Factory schematically.

2. The Neutrino Factory target

Because of the high energy density dissipated in the target and difficulties in removing the heat, it has been proposed to use moving liquid and solid metal targets. A free mercury jet [2] has the advantages of not suffering from radiation damage and being capable of dissipating in excess of 1 MW. The MERIT experiment [3] will be run at CERN next year to test the principle and examine any problems.

Solid targets in the form a rotating metal band [4,5] and small metal spheres cooled by water or helium gas have been suggested [6]. The perceived problem with solid targets has been the thermal shock which could rapidly destroy the target after a few pulses. The problem can be circumvented by making the target from small enough spheres. Solid targets will also be subject to possible radiation damage.

* Corresponding author. Tel.: +44 1235 44 6379; fax: +44 1235 44 5607.
E-mail address: roger.bennett@rl.ac.uk (J.R.J. Bennett).

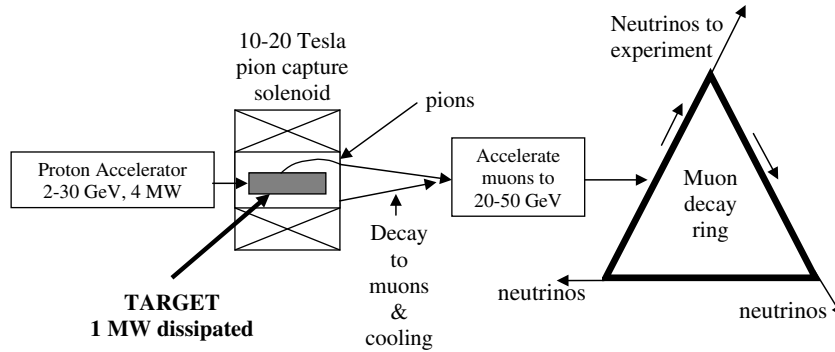

Fig. 1. Schematic view of the Neutrino Factory 'as seen by the target'.

The Neutrino Factory target is not a stopping target. It dissipates a mean power of about 1 MW in a 2–3 cm diameter bar of tungsten about 20 cm long. The remaining 3 MW of beam is absorbed in a beam dump and surrounding equipment. The energy density averaged over the target volume is $\sim 300 \text{ J cm}^{-3}$ per pulse (2 cm diameter target). The mean temperature rise is $\sim 100 \text{ K}$ but the peak temperature rise a few cm into the target where the energy density is greatest, is nearer 200 K – a parabolic transverse beam current distribution is assumed, where the beam radius and the target radius are equal.

A rotating cupro-nickel band was originally proposed by King et al. [4]. The band was guided and driven via rollers and cooled by sprays of water. The suggestion here is for a magnetically levitated rotating tungsten toroid [5,7] cooled by thermal radiation to the surrounding water-cooled vacuum chamber, see Fig. 2. The toroid would be $\sim 10 \text{ m}$ diameter and rotate at 10 m s^{-1} .

An alternative of individual bars is also being considered and a 'new' bar would be presented for each beam pulse. By splitting the magnetic solenoid magnet into two halves the bars could cross the beam transversely so avoiding the pions downstream, see Fig. 3. An alternative arrangement allowing a better solenoid design is also shown in Fig. 4.

The strength [8] of tantalum and tungsten falls severely at high temperatures. To keep the temperature down to $\sim 1800 \text{ K}$ it will be necessary to have about 550 bars (2 cm diameter) circulating. The number could be reduced by increasing the thermal emissivity (0.3 at these temperatures). This can be accomplished by effectively roughening

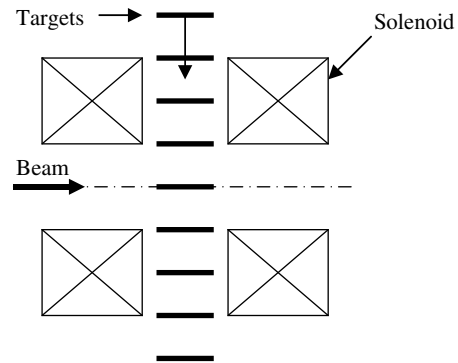

Fig. 3. Schematic diagram of split solenoid and individual target bars traversing the beam.

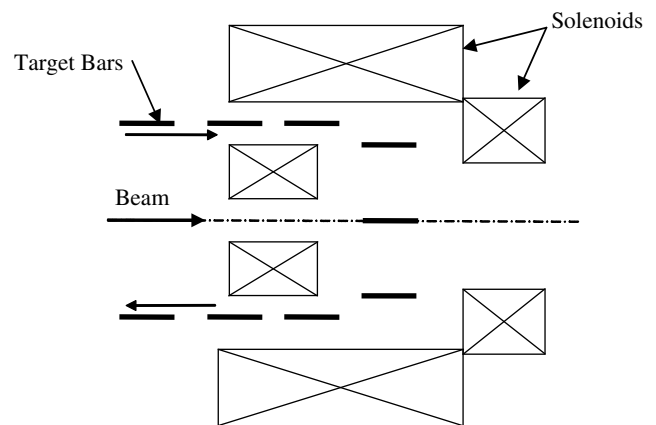

Fig. 4. Individual target bars with alternative solenoid arrangement.

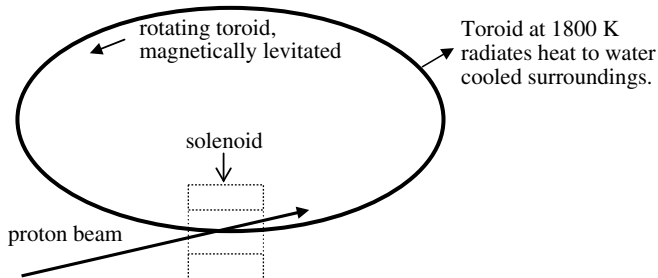

Fig. 2. Schematic diagram of the rotating tungsten toroid.

the surface. With an emissivity of 0.7 the number of bars reduces to 200. The larger target of 3 cm diameter would have 350 bars and 120 bars at the higher emissivity.

The choice of tantalum and tungsten as candidate materials is dictated by the need for a refractory metal. Also these metals have been shown to be extremely resistant to radiation damage effects in the ISIS target [9] up to 12 dpa (similar to the Neutrino Factory target after 10 years of use). However, other studies [10–12] have indicated embrittlement and helium swelling. This discrepancy is not understood and will need further investigation.

3. Thermal shock in solids

If a solid material is heated instantaneously it will not be able to expand immediately to its new equilibrium size because of inertia. Initially the material is under compression before it starts to expand. A relaxation wave passes through the solid from the outside towards the centre and is reflected back as a compression wave.

It is possible to calculate the stress generated in the material in the simple case where the material remains in the elastic region [13]. For a 20 cm long bar of tungsten at 1900 K suffering a temperature rise of 100 K, the instant longitudinal stress is 270 MPa, whereas the measured 0.2% yield and ultimate tensile strengths are only 20 and ~100 MPa, respectively [8]. Hence one would expect the bar to be destroyed after a few pulses.

However, there is some evidence that the process is not straightforward and that it is possible for solids to suffer thermal shock above the simply calculated elastic values. The Pbar target at FNAL withstands energy densities of ~40000 J cm⁻³ [14].

As a result it was decided to make thermal shock measurements on tantalum and tungsten samples to determine their possible life as Neutrino Factory targets. Ideally it would be best to do a full scale life test on a real size target in a beam over 1–10 years. However, beams of this power are not readily available for any length of time.

4. The wire tests

Hence it was decided to pass a fast, high current pulse through a thin wire. In addition, measurements of the surface radial and longitudinal motion of the wire will be made using a VISAR (velocity interferometer system for any reflector) [15]. Coupled with the use of codes to model the thermal shock in the wire it will be possible to find the constitutive equations of state of the material under dynamic conditions. A commercial package, LS-DYNA [16], is being used for these modelling studies. Using the correct constitutive equations for tungsten at high temperatures will allow a better computation of the thermal stresses in a real target of various geometries.

A thin wire is necessary to allow the current to diffuse into the centre of the wire in a sufficiently short time for the shock to be effective. For tantalum and tungsten the wire cannot be greater than ~0.5 mm in diameter. A power supply for the ISIS [17] kicker magnets is being used, supplying a maximum of 60 kV and 10000 A at up to 50 Hz in a pulse which rises in 100 ns and is 800 ns long. The wires, of 3–4 cm length, are supported in a vacuum chamber to avoid oxidation. One end of the wire is firmly clamped and the other end is allowed to expand freely through a pair of graphite (or copper) conductors which lightly clamp the wire. The wire is operated at temperatures of 1600–2000 K by adjusting the pulse repetition rate. The temperature is measured by a manually operated optical pyrometer and an electronic pyrometer, which can measure at up

to 1 kHz rate, allowing the pulse temperature to be measured. The current through the wire is measured by a current transformer. By calculating the Ohmic heating the temperature rise can be cross checked to the electronic pyrometer measurement.

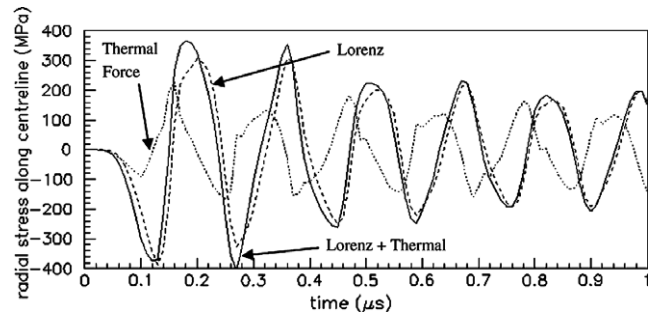

Fig. 5. Radial stress at the axis of the wire due to thermal (dotted line) and Lorentz forces (dashed line).

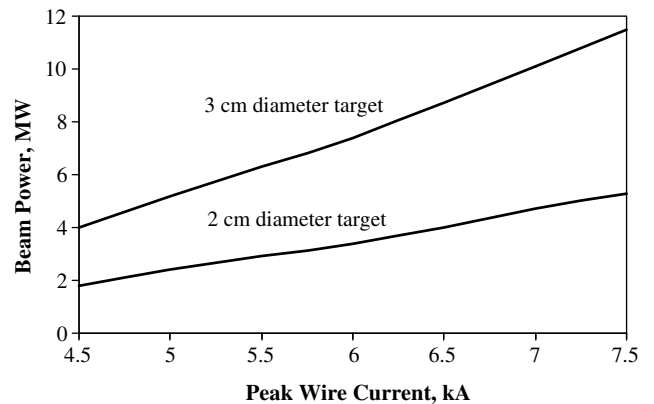

Fig. 6. Beam power into a target of 2 and 3 cm diameter versus wire current for the same peak stress. Beam with 3 micro-pulses at optimum spacing to minimise the stress in the target.

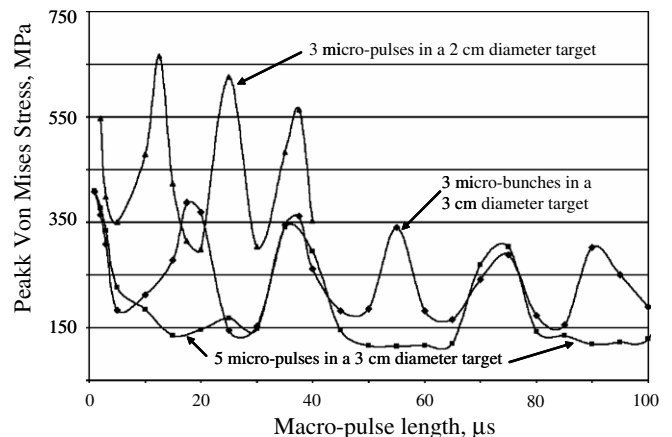

Fig. 7. Variation of peak stress versus macro-pulse length in targets of 2 and 3 cm diameter with 3 and 5 equally spaced micro-pulses (2 ns long).

Table 1
Results of some tantalum and tungsten wire tests

#	Wire material	Current (A)	Pulse temp. (K)	Peak temp. (K)	Number of pulses (Millions)	Equivalent target	
						Beam power (MW)	Target diameter (cm)
1	Tantalum	3000	60	1800	0.2	–	–
<i>Tungsten</i>							
2	Broke when increased to 7200 A (2200 K)	4900	90	2000	>3.4	2 4	2 3
3	Stuck to top copper conductors	6400	150	1900	>1.6	4 8	2 3
4	Not broken top connector failed	5560 5840	120 130	1900 2050	4.2 >9.0	3 6	2 3
5	Stuck to top copper conductors	7000	180	1950	>1.2	4 8	2 3

Only one representative tantalum wire test is shown. The ‘Equivalent target’ columns show the equivalent beam power for a full size target of 2 and 3 cm diameter for the same stress in the test wire. (Assumes a parabolic beam distribution, 3 micro-pulses per macro-pulse of $\sim 20 \mu\text{s}$ and beam diameter equal to target diameter.)

5. Modelling studies and beam pulse structure

MARS [18] calculations have been made of the beam hitting tantalum and tungsten targets to assess the energy deposition and distribution. From this the temperature rise can be calculated. The temperature rises are then used in the LS-DYNA programme to calculate the dynamic stresses in the target. The stress in the wire is calculated including both temperature and the Lorentz force from the magnetic field produced by the current on itself. Fig. 5 shows the stress waves in the wire. Hence it is possible to relate the current in the wire that produces the same peak stress in the full sized target (see Fig. 6).

The magnitude of the thermal stress on the target is governed by the energy density (the temperature rise) and its rate of input. If the energy is put into the target quasi-statically then the target experiences no thermal stress. With the Neutrino Factory there is a requirement for short micro-pulses of 1–2 ns length within a macro-pulse of a few micro-seconds. An odd number of micro-pulses is preferred for the muon accelerator and the more micro-pulses the easier for the proton driver with regard to space charge. As a result, a possible design is for a proton beam of 3 or 5 micro-pulses spaced apart by 5–10 μs . The effect of the pulse structure is shown in Fig. 7.

6. Results

The results of a number of tests with 0.5 mm diameter tantalum and tungsten wires are shown in Table 1. The tantalum was too weak at temperatures of 1400 K or more necessary for the radiant heat dissipation and only one typical result is shown in the table. The tungsten was much more robust and most of the failures occurred in the end connections rather than the wire. In fact the wire only failed when operated at temperatures well over $\sim 2000 \text{ K}$.

The mode of failure is for the wire to buckle, as shown in Fig. 8. It is observed that the wire will both elongate and

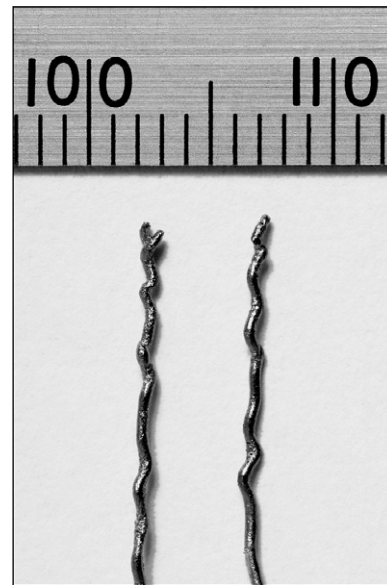

Fig. 8. Photograph of a 0.5 mm diameter tantalum wire after passing a pulse current through it, showing typical buckling and fractures at the bends.

the radius will vary along the length thickening in parts and thinning in others. The behaviour is thought to be predominantly due to the longitudinal shock wave which tries to alternately shorten and lengthen the wire. Under tension the wire elongates but under compression the wire becomes unstable and buckles at its hottest and weakest part. This, plus the radial shock can account for the change in wire radius with position. Calculating these effects is difficult, particularly the unstable conditions, but Skoro has calculated radial changes [19].

7. Conclusions

The investigation of shock in tungsten at high temperatures is just beginning but already it is believed that solid

tungsten targets are able to withstand the thermal stresses from the pulsed beam for at least 10 years and, from the ISIS experience, are not susceptible to radiation damage. Further work is being carried out to characterise tungsten, including radiation damage studies at BNL [20]. It is planned to test a full scale target in a proton beam for at least several thousand pulses to try and confirm the wire tests.

References

- [1] See the proceedings of NuFact from 1999 to 2006, e.g. NuFact05; Nucl. Phys. B 155 (2006) (Proc. Suppl.).
- [2] C.D. Johnson, NuFact99, Lyon, <<http://lyoinfo.in2p3.fr/nufact99/agenda/html>>.
- [3] MERIT Home Page, <<http://proj-hiptarget.web.cern.ch/proj-hiptarget/default.asp?meet=True>>.
- [4] B.J. King, S.S. Moser, R.J. Weggel, N.V. Mokhov, in: Proceedings of the 1999 IEEE Particle Accelerator Conference, New York City, NY, USA, IEEE 99Ch36366, 29 March–2 April, 1999, p. 3041.
- [5] J.R.J. Bennett, AIP Conf. Proc. 542 (2000) 253.
- [6] P. Sievers, Nucl. Instrum. and Meth. A 503 (2003) 344.
- [7] J.R.J. Bennett, Nucl. Instrum. and Meth. A 451 (2000) 344.
- [8] E. Lasner, W.-D. Schubert, Tungsten, Kluwer Academic/Plenum, New York, 1999.
- [9] J. Chen, G.S. Bauer, T.A. Broome, F. Carsughi, Y. Dai, S.A. Malloy, M. Roedig, W.F. Sommer, H. Ullmaier, J. Nucl. Mater. 318 (2003) 56.
- [10] T.S. Byun, S.A. Maloy, J. Nucl. Mater. 377 (2008) 72.
- [11] P. Hosemann, G. Swadener, D. Byler, S.A. Maloy, T. Romero, E. Pitcher, Y. Dai, these Proceedings.
- [12] B.M. Oliver, F.A. Garner, M.L. Hamilton, W.F. Sommer, S.A. Maloy, P.D. Ferguson, M.R. James, Effects of Radiation on Materials: 20th International Symposium, ASTM STP 1405, 2001, p. 612.
- [13] S.P. Timoshenko, J.N. Goodier, Theory of Elasticity, McGraw-Hill Book Co., New York, 1970.
- [14] P. Hurh, FNAL, Private Communication.
- [15] L.M. Barker, R.E. Hollenbach, J. Appl. Phys. 43 (1972) 4669.
- [16] Livermore Software Technology Corp., <<http://www.lstc.com/>>.
- [17] See the ISIS web site <<http://www.isis.rl.ac.uk/>>.
- [18] N. Mokhov, <<http://www-ap.fnal.gov/MARS>>.
- [19] G. Skoro, NuFact06, <http://hepunix.rl.ac.uk/uknf/wp3/shocksims/NuFact06/GSkoro_NuFact06.ppt#1>.
- [20] N. Simos, these Proceedings.